

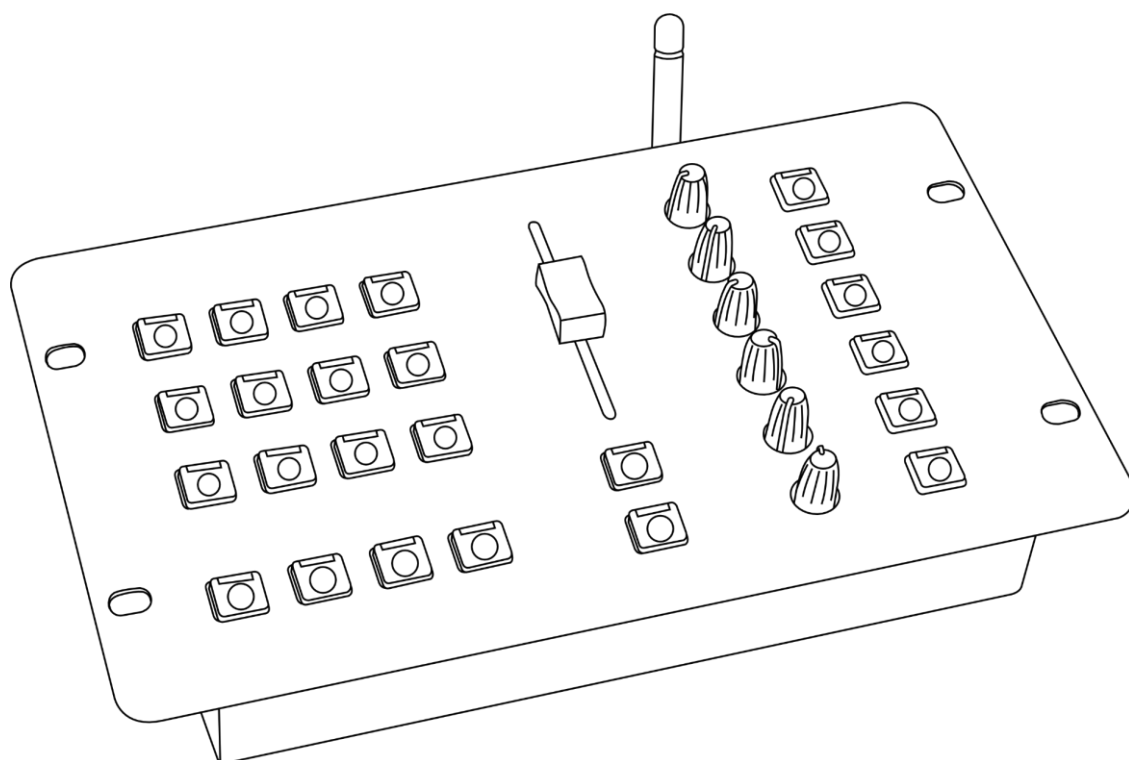

USER MANUAL



ENGLISH

ColorCue 1 AIR

V1

Product code: 50707

Preface

Thank you for purchasing this Showtec product.

The purpose of this user manual is to provide instructions for the correct and safe use of this product.

Keep the user manual for future reference as it is an integral part of the product. The user manual shall be stored at an easily accessible location.

This user manual contains information concerning:

- Safety instructions
- Installation and operation of the device
- Intended and non-intended use of the device
- Maintenance procedures
- Troubleshooting
- Transport, storage and disposal of the device

Non-observance of the instructions in this user manual may result in serious injuries and damage of property.

©2023 Showtec. All rights reserved.

No part of this document may be copied, published or otherwise reproduced without the prior written consent of Highlite International.

Design and product specifications are subject to change without prior notice.

For the latest version of this document or other language versions, please visit our website www.highlite.com or contact us at service@highlite.com.

Highlite International and its authorized service providers are not liable for any injury, damage, direct or indirect loss, consequential or economic loss or any other loss arising from the use of, or inability to use or reliance on the information contained in this document.

Table of contents

1. Introduction	4
1.1. Before Using the Product	4
1.2. Intended Use	4
1.3. Product Lifespan	4
1.4. Text Conventions	4
1.5. Symbols and Signal Words	5
1.6. Symbols on the Information Label	5
2. Safety	6
2.1. Warnings and Safety Instructions	6
2.2. Requirements for the User	7
3. Description of the Device	8
3.1. Top View	8
3.2. Back View	9
3.3. Product Specifications	10
3.4. Optional Accessories	11
3.5. Dimensions	11
3.5.1. Mounting Dimensions	11
4. Installation	12
4.1. Installation Site Requirements	12
4.2. Mounting	12
4.3. Charging the Battery	12
4.3.1. Battery Statuses	13
5. Setup	14
5.1. Warnings and Precautions	14
5.2. DMX Connection	14
5.2.1. DMX-512 Protocol	14
5.2.2. DMX Cables	14
5.3. Setup Options	15
5.3.1. Wired DMX Setup	15
5.3.2. Wireless DMX Setup	16
5.4. Connecting to Power Supply	17
5.5. Switching On	17
5.6. Linking (Wireless DMX)	17
6. Operation	18
6.1. Safety Instructions for Operation	18
6.2. Setup Mode	18
6.3. Operating Modes	19
6.3.1. Manual Mode	19
6.3.2. Static Colors Mode	19
6.3.2.1. Preset Colors Mode	19
6.3.2.2. User Colors Mode	20
6.3.3. Chase Mode	20
6.3.3.1. Preset Chase Mode	20
6.3.3.2. User Chase Mode	21
6.4. Operating Functions	21
6.4.1. Strobe	21
6.4.2. Blackout	21
6.4.3. Chase Playback	21
6.4.4. Cancel a Selection	22
6.5. Programming Mode	22
6.5.1. Record a Color	22
6.5.2. Delete a Color	22
6.5.3. Record a Chase Step	23

- 6.5.4. Add a Chase Step to an Existing Chase23
- 6.5.5. Delete a Chase Step24
- 6.5.6. Delete a Chase.....24
- 6.6. Factory Reset24
- 7. Troubleshooting25**
- 8. Maintenance26**
 - 8.1. Preventive Maintenance26
 - 8.1.1. Basic Cleaning Instructions26
 - 8.2. Corrective Maintenance26
- 9. Deinstallation, Transportation and Storage27**
 - 9.1. Instructions for Transportation27
 - 9.2. Storage27
- 10. Disposal27**
- 11. Approval.....27**

1. Introduction

1.1. Before Using the Product



Important

Read and follow the instructions in this user manual before installing, operating or servicing this product.

The manufacturer will not accept liability for any resulting damages caused by the non-observance of this manual.

After unpacking, check the contents of the box. If any parts are missing or damaged, contact your Highlite International dealer.

Your shipment includes:

- Showtec ColorCue 1 AIR
- AC power adapter with 4 interchangeable AC plugs (Europe, UK, US/JP, AUS/NZ)
- User manual

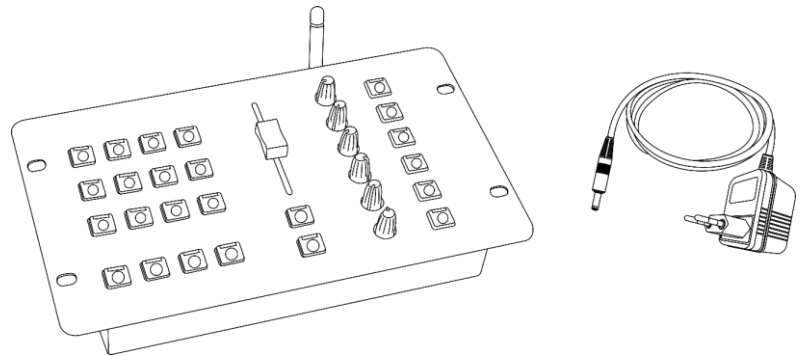

Fig. 01

1.2. Intended Use

This device is intended for use as a wireless LED DMX controller. It is suitable only for indoor installation. It is not suitable for households.

Any other use, not mentioned under intended use, is regarded as non-intended and incorrect use.

1.3. Product Lifespan

This device is not designed for permanent operation. Disconnect the device from the electrical power supply when the device is not in operation. This will reduce the wear and will improve the device's lifespan.

1.4. Text Conventions

Throughout the user manual the following text conventions are used:

- References: References to chapters and parts of the device are in bold lettering, for example: "Refer to **2. Safety**", "press the **power switch (03)**"
- 0–255: Defines a range of values
- Notes: **Note:** (in bold lettering) is followed by useful information or tips

1.5. Symbols and Signal Words

Safety notes and warnings are indicated throughout the user manual by safety signs.

Always follow the instructions provided in this user manual.



DANGER

Indicates an imminently hazardous situation which, if not avoided, will result in death or serious injury.



WARNING

Indicates an imminently hazardous situation which, if not avoided, could result in death or serious injury.



CAUTION

Indicates a potentially hazardous situation, which, if not avoided, may result in minor or moderate injury.



Attention

Indicates important information for the correct operation and use of the product.



Important

Read and observe the instructions in this document.



Provides important information about the disposal of this product.



1.6. Symbols on the Information Label

This product is provided with an information label. The information label is located on the bottom plate of the device.

The information label contains the following symbols:



This device is designed for indoor use.



Read and follow the instructions in the user manual before installing, operating or servicing the device.



This device falls under IEC protection class II.



This device shall not be treated as household waste.



2. Safety



Important

Read and follow the instructions in this user manual before installing, operating or servicing this product.

The manufacturer will not accept liability for any resulting damages caused by the non-observance of this manual.

2.1. Warnings and Safety Instructions



DANGER

Danger for children

For adult use only. The device must be installed beyond the reach of children.

- Do not leave various parts of the packaging (plastic bags, polystyrene foam, nails, etc.) within children's reach. Packaging material is a potential source of danger for children.



DANGER

Risk of explosion caused by incorrect handling

This device contains a built-in rechargeable lithium-ion battery. The battery is not replaceable. The battery may explode or cause burns if it is crushed, disassembled or exposed to fire or high temperatures.

- Do not open the device and do not attempt to remove the built-in battery.
- Do not disassemble the battery.
- Do not crush or puncture the battery.
- Do not short-circuit the battery.
- Do not expose the battery to water or other liquids.
- Keep the battery away from fire and heat.



Attention

Incorrect handling of the AC power adapter may result in hazardous situations

This device is delivered with an AC power adapter. Incorrect handling of the AC power adapter may result in hazardous situations.

- Use only the AC power adapter delivered with the device.
- Do not wrap the power cable around the power adapter or any other object. This can damage the internal wires.
- Do not cover the power adapter with anything when it is plugged into the socket-outlet. This may cause overheating.
- Do not expose the power adapter to water or other liquids.

Do not use the power adapter:

- If it shows signs of overheating, for example the plastic is damaged
- If the AC input pins show signs of corrosion or overheating
- If the power cable is damaged or shows signs of material fatigue.



Attention
General safety

- Do not shake the device. Avoid brute force when installing or operating the device.
- If the device is exposed to extreme temperature variations (e.g. after transportation), do not switch it on immediately. Let the device reach room temperature before switching it on, otherwise it may be damaged by the formed condensation.



Attention
This device shall be used only for the purposes it is designed for.

This device is designed to be used as a wireless LED DMX controller. Any incorrect use may lead to hazardous situations and result in injuries and material damage.

This device does not contain user-serviceable parts. Unauthorized modifications to the device will render the warranty void. Such modifications may result in injuries and material damage.



Attention
Do not expose the device to conditions that exceed the rated IP class conditions.

This device is IP20 rated. IP (Ingress Protection) 20 class provides protection against solid objects greater than 12 mm, such as fingers, and no protection against harmful ingress of water.

2.2. Requirements for the User

This product may be used by ordinary persons. Maintenance and installation may be carried by ordinary persons. Service shall be carried out only by instructed or skilled persons. Contact your Highlite International dealer for more information.

Instructed persons have been instructed and trained by a skilled person, or are supervised by a skilled person, for specific tasks and work activities associated with the service of this product, so that they can identify risks and take precautions to avoid them.

Skilled persons have training or experience, which enables them to recognize risks and to avoid hazards associated with the service of this product.

Ordinary persons are all persons other than instructed persons and skilled persons. Ordinary persons include not only users of the product but also any other persons that may have access to the device or who may be in the vicinity of the device.

3. Description of the Device

The Showtec ColorCue 1 AIR is a LED DMX controller with wireless DMX, featuring 1 master fader, 6 color rotary encoders and 12 memory buttons for colors/chases/user presets. You can use the device to control the light output of LED fixtures with up to 6 colors (RGBWA-UV), suitable for any venue. The device has 12 customizable preset colors and 12 fixed colors. You can create up to 12 programs (chases), each with up to 99 steps. Control the chases in Manual, Auto or Sound-controlled mode. Thanks to the presence of wireless DMX and of the internal battery (good for up to 12 hours of operation), you do not need to use power or DMX cables to operate the device.

3.1. Top View

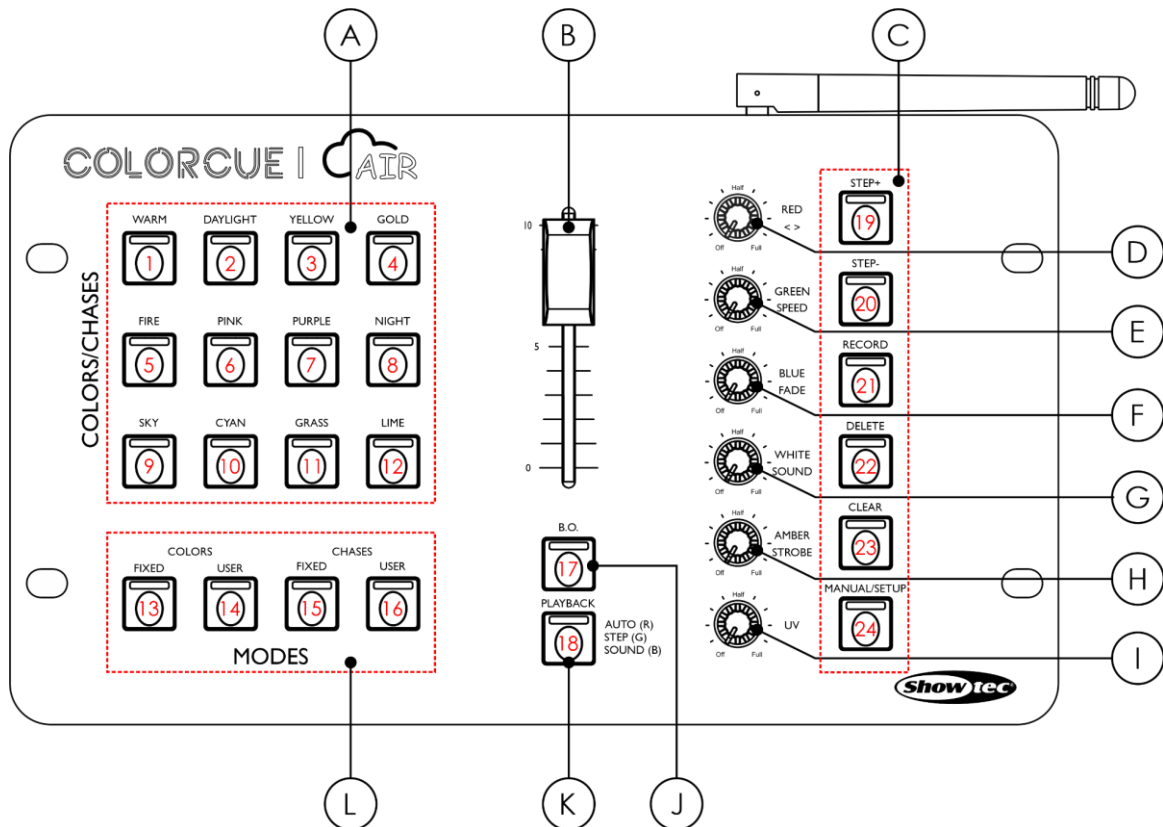

Fig. 02

- A) Colors/Chases buttons with LEDs **(1)–(12)**
- B) Master fader
- C) Function buttons with LEDs **(19)–(24)**
- D) Red/Direction control
- E) Green/Speed control
- F) Blue/Fade control
- G) White/Sound control
- H) Amber/Strobe control
- I) UV control
- J) Blackout button
- K) Playback button
- L) Mode buttons **(13)–(16)**

3.2. Back View

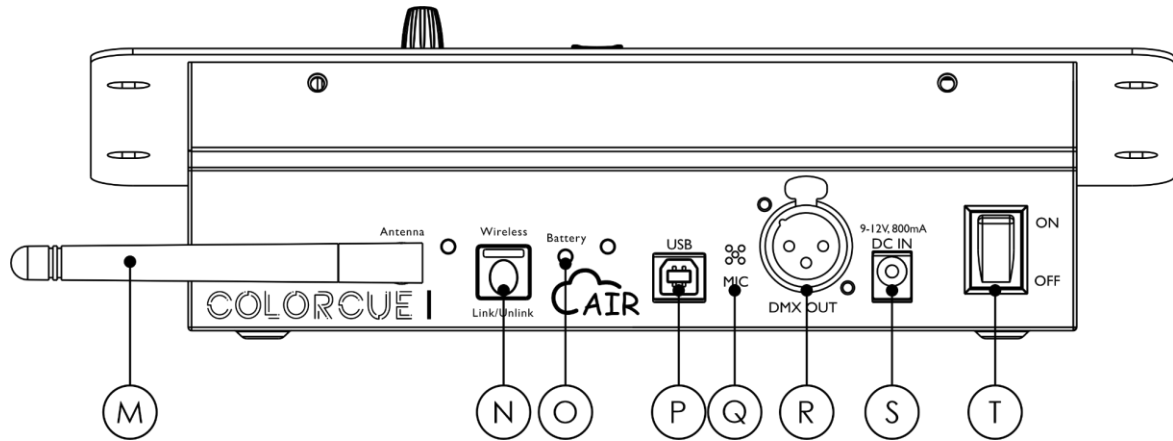

Fig. 03

- M) Antenna
- N) Wireless Link/Unlink button
- O) Battery LED indicator
- P) USB connector (no function)
- Q) Microphone
- R) 3-pin DMX connector OUT
- S) DC input connector (9–12 V DC, 800 mA)
- T) Power switch (ON/OFF)

3.3. Product Specifications

Model:	ColorCue 1 AIR
Electrical:	
Input voltage:	9–12 V DC, 800 mA
Power consumption:	10 W
Audio triggers:	1
AC power adapter:	
Input voltage:	100–240 V AC, 50/60 Hz
Input current:	0,5 A max
Output voltage:	12 V DC
Output current:	1,5 A
Physical:	
Dimensions:	258 x 150 x 79 mm (L x W x H)
Rack units:	3 U
Installation depth:	79 mm
Weight:	1,1 kg
Operation and control:	
Control modes:	Built-in programs, Manual, Sound, Static dimmer
DMX channels:	6 channels
Faders:	1
Buttons:	25
Memories:	1212
Control protocol:	DMX-512, wireless DMX
Wireless Specifications:	
Wireless mode:	G3
Carrier frequency:	2,4 GHz
Gain:	10 mW
Reaction time:	8 ms
Antenna type:	Omni
Antenna radiation:	360° x 360°
Battery:	
Battery type:	Lithium-ion
Battery voltage:	7,4 V
Capacity:	2,6 Ah
Runtime (@full):	10 h
Runtime average:	12 h
Charging time:	6 h
Connections:	
Power connection:	DC input connector
Input connections:	USB input connector (no function)
Output connections:	3-pin DMX connector OUT
Construction:	
Housing:	Metal
Color:	Gray
IP rating:	IP20
Thermal:	
Maximum ambient temperature t_a :	40 °C
Minimum ambient temperature t_a :	-5 °C

3.4. Optional Accessories

There is a flight case available for the ColorCue 1 AIR. Purchase the flight case separately.

You need to remove the accessory bay of the flight case. Otherwise, the device does not fit in the flight case.

- [D7405](#) (Case for ColorCue 1)

You can replace the **antenna (M)** with one of the 2 antennas that extend the wireless range of the device. Purchase the antenna(s) separately.

- [50155](#) (Indoor Omni Antenna – 2,4 GHz, 5 dBi)
- [50157](#) (Indoor Omni Antenna – 2,4 GHz, 7 dBi)

3.5. Dimensions

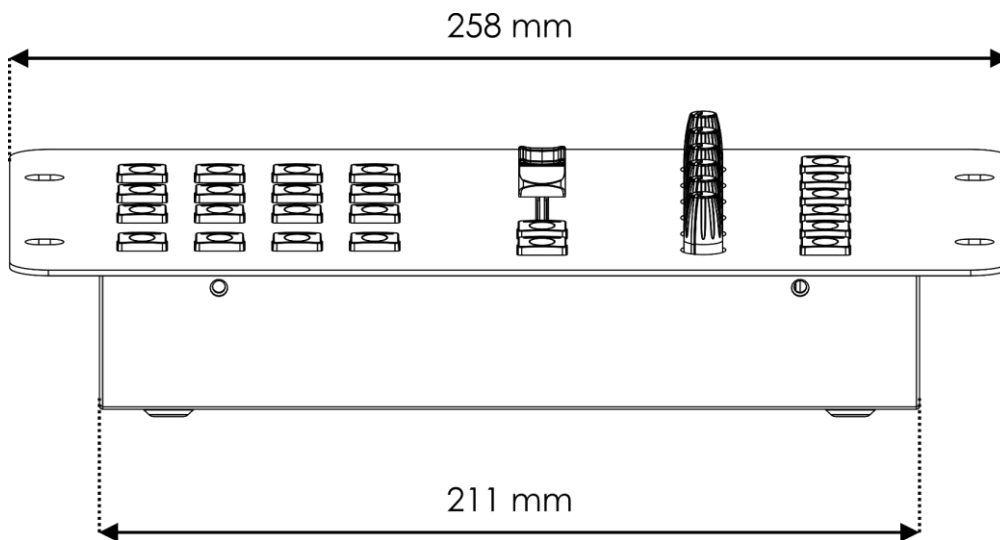

Fig. 04

3.5.1. Mounting Dimensions

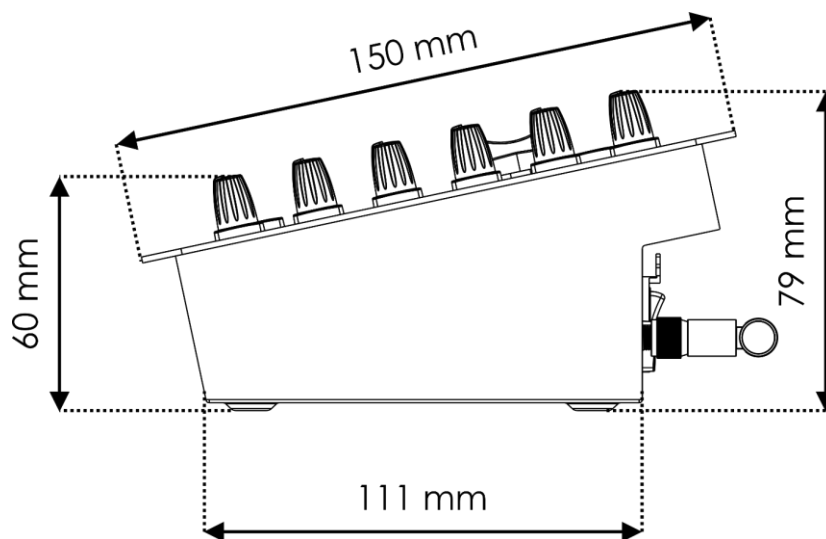

Fig. 05

4. Installation

4.1. Installation Site Requirements

- The device must be installed only indoors.
- The device can be positioned on a stable, flat surface, or mounted vertically or horizontally in an opening.
- The device can be operated from the flight case. See **3.4. Optional Accessories** on page 11.
- The maximum ambient temperature $t_a = 40\text{ °C}$ must never be exceeded.
- The relative humidity must not exceed 50 % with an ambient temperature of 40 °C .

4.2. Mounting

The device can be mounted vertically or horizontally in an opening. Make sure that there is enough space for ventilation and for the connected cables. See **3.5.1. Mounting Dimensions** on page 11.

Fasten the device with 4 screws to the mounting surface.

4.3. Charging the Battery



DANGER
Risk of explosion caused by incorrect handling

This device contains a built-in rechargeable lithium-ion battery. The battery is not replaceable. The battery may explode or cause burns if it is crushed, disassembled or exposed to fire or high temperatures.

- Do not open the device and do not attempt to remove the built-in battery.
- Do not crush or puncture the battery.

This device is delivered with an AC power adapter that is used to charge the battery. Before connecting the power adapter to the socket-outlet, make sure that the power supply matches the input voltage specified on the AC power adapter.

To charge the battery follow the steps below:

- 01) Press the **power switch (T)** to ON position.
- 02) Connect the AC power adapter to **DC input connector (S)**. Use only the AC power adapter delivered with the device.
- 03) Connect the AC power adapter to the socket-outlet.

The **battery LED indicator (O)** changes colors depending on the battery status. See **4.3.1. Battery Statuses** on page 13.



- Charge the battery before using the device for the first time.
- Do not deep discharge the battery as this will shorten the battery's lifetime. Recharge the battery as early as possible. Do not let the device operate until the battery is depleted.
- Make sure that the battery is charged to at least 50 % before storing the device.

It is recommended to charge the device at an ambient temperature between 0 °C and 35 °C .

Refer to **3.3. Product Specifications** on page 10 for the charge time of the battery.

4.3.1. Battery Statuses

The **battery LED indicator (O)** shows the status of the lithium-ion battery:

LED color	LED behavior	Status
 Red	Lights up	Battery is almost depleted
 Orange	Lights up	Battery is low
 Green	Lights up	Battery is (fully) charged

5. Setup

5.1. Warnings and Precautions



Attention
Connect all data cables before supplying power.
Disconnect power supply before connecting or disconnecting data cables.

5.2. DMX Connection

5.2.1. DMX-512 Protocol

DMX-512 is a communication protocol used to control stage lighting and effects.

Devices on a serial data link must be daisy-chained in a single line. To comply with the TIA-485 standard, no more than 32 devices should be connected on one data link.

In order to connect more than 32 devices on one data link, you can use a DMX optically isolated splitter/booster. If no splitter/booster is used, this may result in deterioration of the DMX signal.

5.2.2. DMX Cables

Shielded twisted-pair cables with 3-pin XLR connectors must be used for reliable DMX connection. You can purchase DMX cables directly from your Highlite International dealer or make your own cables.

If you use XLR audio cables for DMX data transmission, this may lead to signal degradation and unreliable operation of the DMX network.

When you make your own DMX cables, make sure that you connect the pins and wires correctly as shown in Fig. 06.

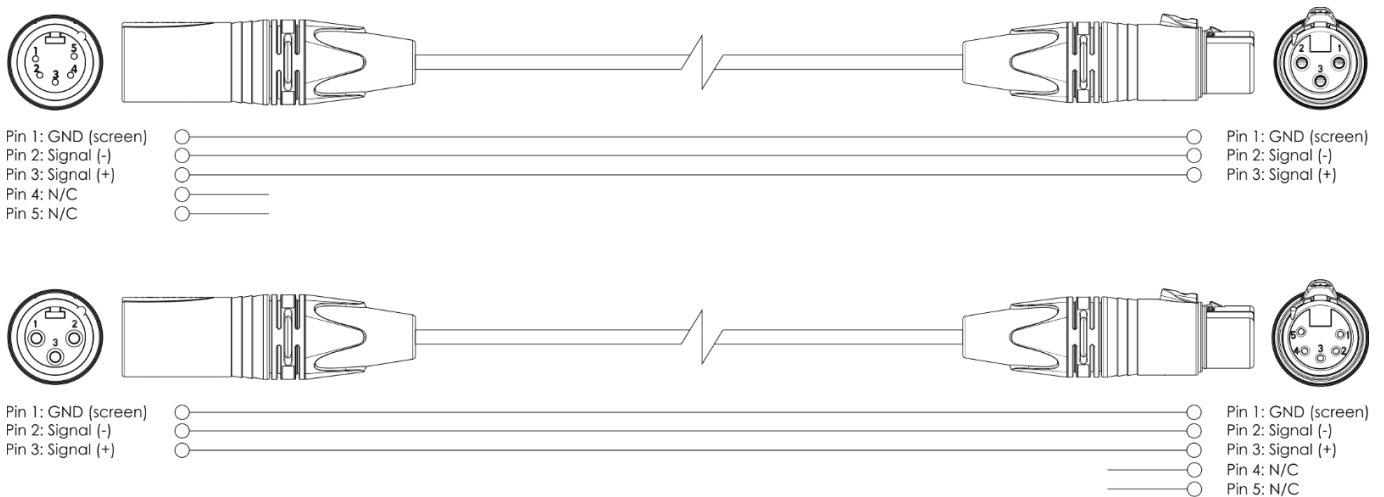

Fig. 06

5.3. Setup Options

You can use the device to control lighting fixtures in 2 ways:

- with wired DMX: 1 lighting fixture with up to 6 channels (RGBWA-UV). See **5.3.1. Wired DMX Setup** on page 15.
- with wireless DMX: Multiple lighting fixtures. See **5.3.2. Wireless DMX Setup** on page 16.

5.3.1. Wired DMX Setup

To connect the device in a wired DMX setup, follow the steps below:

- 01) Use a DMX cable to connect the **3-pin DMX connector OUT (R)** to the DMX IN connector of the lighting fixture.
- 02) Power the device. See **5.4. Connecting to Power Supply** on page 17.
- 03) Switch on the device. See **5.5. Switching On** on page 17.
- 04) Power the lighting fixture.

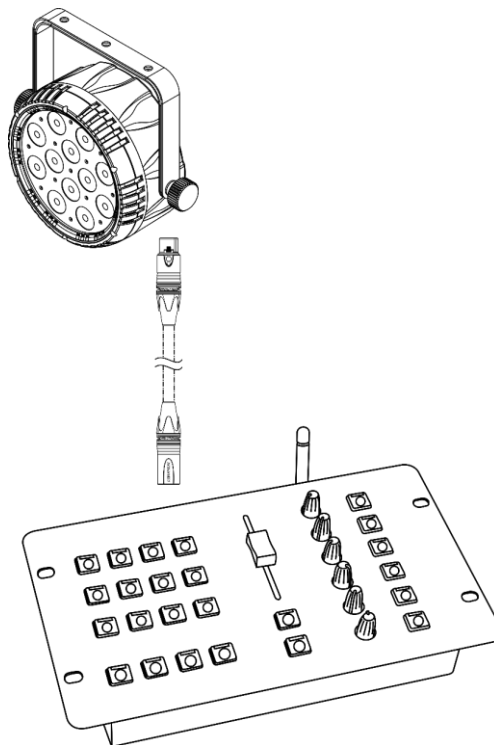

Fig. 07

5.3.2. Wireless DMX Setup

To link the device to multiple lighting fixtures in a wireless DMX setup, follow the steps below:

- 01) Power the device. See **5.4. Connecting to Power Supply** on page 17.
- 02) Switch on the device. See **5.5. Switching On** on page 17.
- 03) Put the **antenna (M)** in upright position.
- 04) Power the lighting fixtures.
- 05) Activate wireless DMX on the lighting fixtures.
- 06) Set the DMX starting address of the lighting fixtures to 001.
- 07) Link the device with the lighting fixtures. See **5.6. Linking (Wireless DMX)** on page 17.

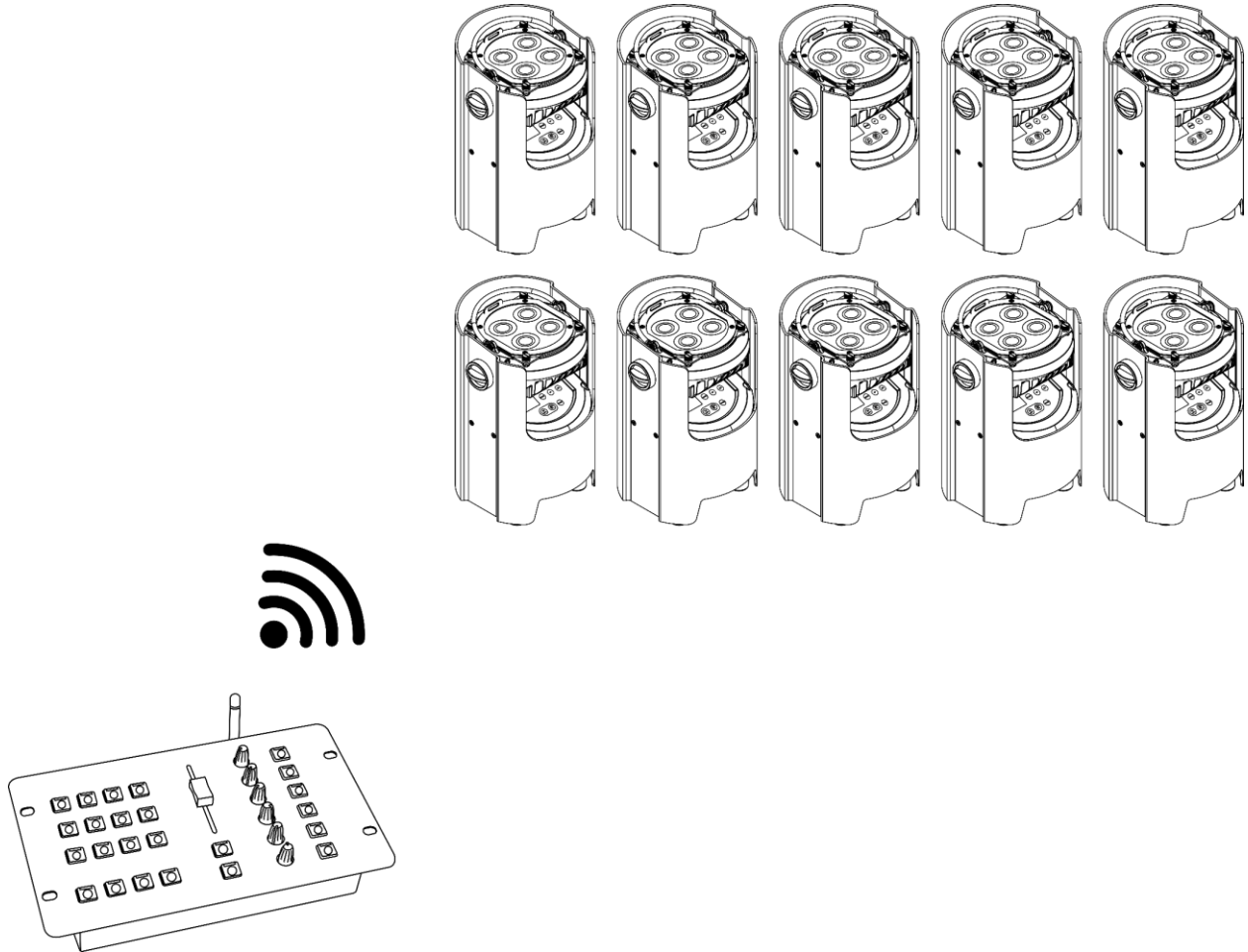

Fig. 08

5.4. Connecting to Power Supply



Attention
Incorrect handling of the AC power adapter may result in hazardous situations

This device is delivered with an AC power adapter. Incorrect handling of the AC power adapter may result in hazardous situations.

Connect the device to the socket-outlet with the delivered AC power adapter. Use only the AC power adapter delivered with the device.

5.5. Switching On

The device has a power switch.

- Press the **power switch (T)** in ON position to switch on the ColorCue 1 AIR.
- Press the **power switch (T)** in OFF position to switch off the ColorCue 1 AIR.

5.6. Linking (Wireless DMX)



You can link the device with lighting fixtures that have a wireless DMX receiver.

Before linking, make sure that the lighting fixtures are not linked with any other transmitter. Otherwise, it will not be possible to link the lighting fixtures.

The device has a **wireless link/unlink button (N)**.

- To link the devices, press the **wireless link/unlink button (N)** once.
- To unlink the devices, press and hold down the **wireless link/unlink button (N)** for 3 seconds.

The LED indicator on the **wireless link/unlink button (N)** shows the wireless DMX status:

LED color	LED behavior	Status
 Red	Flashing	Unlinked
 Red, Blue	Flashing	Linking in progress
 Blue	Lights up	The device is sending wireless DMX signal

Note:

The LED indicator on the **wireless link/unlink button (N)** does not show if the device is linked to any fixture.

6. Operation

6.1. Safety Instructions for Operation



Attention

This device must be used only for the purposes it is designed for.

This device is intended for use as a wireless LED DMX controller. It is suitable only for indoor installation. It is not suitable for households.

Any other use, not mentioned under intended use, is regarded as non-intended and incorrect use.

6.2. Setup Mode

In this mode you can select the type of the LEDs of the connected lighting fixture(s).

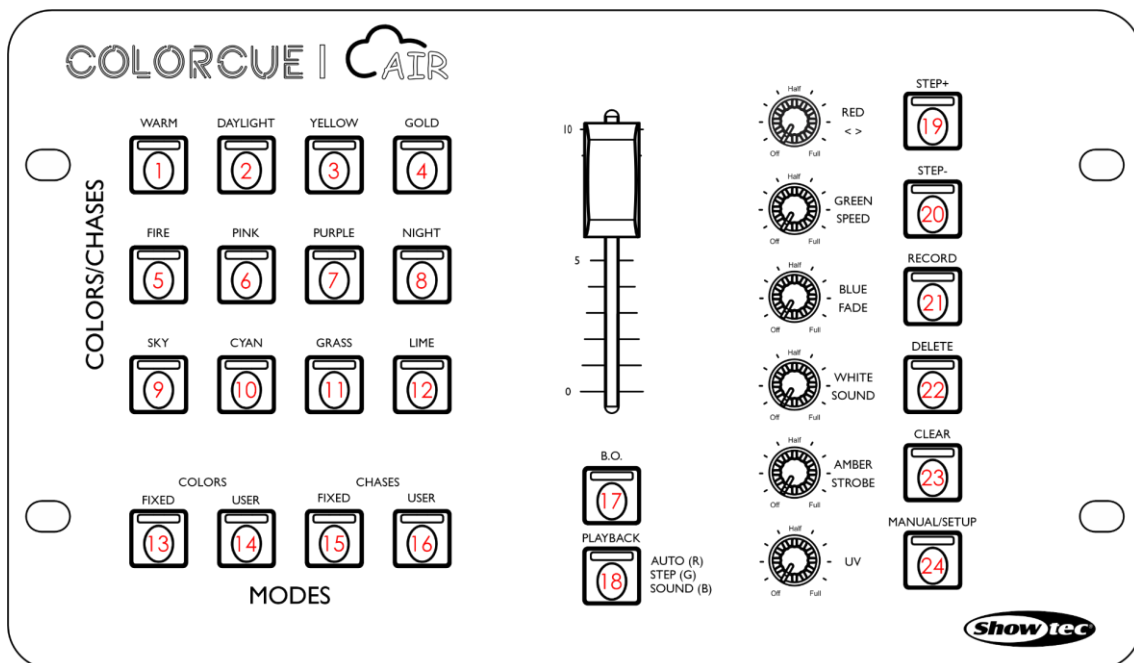

Fig. 09

- 01) Press and hold down the **MANUAL/SETUP button (24)** for 3 seconds. The LED on the button starts blinking.
- 02) Press one of the following 6 buttons to select the LEDs type of the fixture:
 - **(1)** RGB
 - **(2)** RGBW
 - **(3)** RGBA
 - **(4)** RGBWA
 - **(5)** RGBWA-UV (default setting)
 - **(6)** RGBW-UV

The LED on the selected button lights up.

- 03) Press and hold down the **MANUAL/SETUP button (24)** for 3 seconds to exit setup mode. The LED on the button stops blinking.

6.3. Operating Modes

The device has 3 operating modes:

- Manual
- Static Colors (preset/user colors)
- Chase Mode (preset/user chases)

6.3.1. Manual Mode

In this mode you can adjust the intensity of the colors (red, green, blue, white, amber and UV) of the connected fixtures.

To adjust the intensity of the colors:

- 01) Press the **MANUAL/SETUP button (24)** to enter Manual mode. The LED on the button lights up.
- 02) Turn the **controls (D)–(I)** to select a color.

Note:

If you want to clear a selection, press the **CLEAR button (23)**.

- 03) Press the **MANUAL/SETUP button (24)** again to exit Manual mode. The LED on the button turns off.

Note:

To enter Manual mode from preset colors mode and manually adjust a color, you need to fetch the last output value of the respective color.

Turn the **controls (D)–(I)** clockwise or counterclockwise to fetch the value.

6.3.2. Static Colors Mode

In this mode you can select one of the 12 preset colors or 12 user-recorded colors.

6.3.2.1. Preset Colors Mode

In this mode you can select one of the 12 preset colors (warm white, daylight, yellow, gold, fire, pink, purple, night blue, sky blue, cyan, grass, lime).

- 01) Press the **FIXED COLORS button (13)** to enter the Preset Colors mode. The LED on the button lights up.
- 02) Press one of the **COLORS/CHASES buttons (1)–(12)** to select a preset color. The LED on the button lights up.
- 03) Turn the **AMBER/STROBE control (H)** to add strobe effect. The adjustment range is from low to high frequency.
- 04) Press the **FIXED COLORS button (13)** to exit the Preset Colors mode. The LED on the button turns off.

The preset colors have the following DMX values:

Button	Preset color	Red	Green	Blue	White	Amber	UV
1	Warm White	245	225	105	60	235	0
2	Daylight	255	230	155	155	0	0
3	Yellow	255	230	0	0	135	0
4	Gold	255	115	0	0	255	0
5	Fire	200	50	0	0	50	0
6	Pink	255	0	127	0	0	255
7	Purple	220	0	255	0	0	255
8	Night Blue	25	0	255	0	0	255

Button	Preset color	Red	Green	Blue	White	Amber	UV
9	Sky Blue	0	127	255	80	0	255
10	Cyan	0	255	255	0	0	200
11	Grass	50	255	0	0	127	0
12	Lime	195	255	0	50	140	0

6.3.2.2. User Colors Mode

In this mode you can select a user-recorded color. Please refer to **6.5.1. Record a Color** on page 22 for more information.

To select a previously recorded color:

- 01) Press the **USER COLORS button (14)** to enter the User Colors mode. The LED on the button lights up.
- 02) Press one of the **COLORS/CHASES buttons (1)–(12)** to select a user color. The LED on the button lights up.
- 03) Turn the **AMBER/STROBE control (H)** to add strobe effect. The adjustment range is from low to high frequency.
- 04) Press the **USER COLORS button (14)** to exit the User Colors mode. The LED on the button turns off.

6.3.3. Chase Mode

In this mode you can play one of the 12 preset chases or 12 user-recorded chases.

6.3.3.1. Preset Chase Mode

In this mode you can play one of the 12 preset chases.

To play one of the 12 preset chases:

- 01) Press the **FIXED CHASES button (15)** to enter Preset Chase mode. The LED on the button lights up.
- 02) Press one of the **COLORS/CHASES buttons (1)–(12)** to select a preset chase. The LED on the button lights up.
- 03) Repeatedly press the **PLAYBACK button (18)** until the LED on the button lights up in the color corresponding to the playback option. See **6.4.3. Chase Playback** on page 21 for more information.

The preset chases have the following color sequences:

Button	Chases	Color 1	Color 2	Color 3	Color 4	Color 5	Color 6
1	Program 1	Red	Green				
2	Program 2	Red	Blue				
3	Program 3	Green	Blue				
4	Program 4	Red	White				
5	Program 5	Green	White				
6	Program 6	Blue	White				
7	Program 7	White	Amber				
8	Program 8	Pink	Yellow				
9	Program 9	Pink	Cyan				
10	Program 10	Yellow	Magenta				
11	Program 11	Red	Green	Blue			
12	Program 12	Red	Green	Blue	Cyan	Magenta	Yellow

6.3.3.2. User Chase Mode

In this mode you can play a user-recorded chase. Please refer to **6.5.3. Record a Chase Step** on page 23.

To play a previously recorded chase:

- 01) Press the **USER CHASES button (16)** to enter User Chase mode. The LED on the button lights up.
- 02) Press one of the **COLORS/CHASES buttons (1)–(12)** to select a user-recorded chase. The LED on the button lights up.
- 03) Repeatedly press the **PLAYBACK button (18)** until the LED on the button lights up in the color corresponding to the playback option. See **6.4.3. Chase Playback** on page 21 for more information.

6.4. Operating Functions

6.4.1. Strobe

You can add strobe effect at any time during playback of a scene or a chase.

Turn the **AMBER/STROBE control (H)** to add strobe effect. The adjustment range is from low to high frequency.

Note:

The strobe effect cannot be recorded in a scene or a chase.

6.4.2. Blackout

You can activate the blackout function at any time during playback of a scene or a chase.

Press the **BLACKOUT button (17)** to black out the light output of all fixtures. The LED on the button starts blinking.

6.4.3. Chase Playback

There are 3 playback options.

Press the **PLAYBACK button (18)** repeatedly until the LED on the button lights up in the color corresponding to the playback option.

- Auto playback: The LED on the button lights up red. Turn the **GREEN/SPEED control (E)** to decrease/increase the speed. The chase plays automatically. If the **GREEN/SPEED control (E)** is in OFF position, the chase does not play.
- Step playback (manual): The LED on the button lights up green. Press the **STEP+ (19)** or the **STEP- (20)** buttons to manually select a step from the chase step sequence.
- Sound-controlled playback: The LED on the button lights up blue. The chase reacts to the beat of the music. Turn the **WHITE/SOUND control (G)** to adjust the sensitivity of the built-in microphone.

You can also adjust the following parameters during playback of the chase:

- Chase direction: Turn the **RED/Direction control (D)** to change the direction of the chase. In OFF position (**<**) the chase plays backwards. In FULL position (**>**) the chase plays forwards.
- Speed: Turn the **GREEN/SPEED control (E)** to decrease/increase the speed of the chase.
- Fade: Turn the **BLUE/FADE control (F)** to decrease/increase the fade time between the steps.

Fade time cannot be adjusted during manual playback and sound-controlled playback.

- Strobe: Turn the **AMBER/STROBE control (H)** to add strobe effect to the chase. The adjustment range is from low to high frequency.

6.4.4. Cancel a Selection

To cancel a selection in Static Colors mode and Chase mode:

- Press the same **COLORS/CHASES button (1)–(12)** again. The LED on the button turns off.
- Press another **COLORS/CHASES button (1)–(12)** to select a new color/chase. This cancels the current selection and activates the new one. The LED on the selected button lights up.

6.5. Programming Mode

In this mode you can create a custom color or a chase and assign it to one of the 12 **COLORS/CHASES buttons (A)**. The stored user colors/chases can be played in User Color mode and User Chase mode. See page 20 for more information.

6.5.1. Record a Color

To record a color:

- 01) Press and hold down the **RECORD button (21)** for 3 seconds to enter programming mode. The LED on the button starts blinking.
- 02) Press the **MANUAL/SETUP button (24)** to enter manual mode. The LED on the button lights up.
- 03) Turn the **controls (D)–(I)** to select a color. The available colors are Red, Green, Blue, White, Amber and UV.
- 04) Turn the control clockwise to increase the color intensity.
- 05) Press the **USER COLORS button (14)**. The LED on the button lights up.
- 06) Press the **RECORD button (21)** and one of the **COLORS/CHASES buttons (1)–(12)** at the same time, to save the color and assign it to a button. The LED on the selected **COLORS/CHASES button (1)–(12)** blinks 3 times.

Note:

Press a **COLORS/CHASES button (1)–(12)** to make sure that no color is assigned to it. If the LED on the button lights up, the button is not free.

Press and hold down the **RECORD button (21)** for 3 seconds to exit the mode. The LED on the button turns off.

6.5.2. Delete a Color

To delete a color:

- 01) Press and hold down the **RECORD button (21)** for 3 seconds to enter programming mode. The LED on the button starts blinking.
- 02) Press the **USER COLORS button (14)**. The LED on the button lights up.
- 03) Press the **DELETE button (22)** and the **COLORS/CHASES buttons (1)–(12)** at the same time, to delete the color. The LED on the **COLORS/CHASES button (1)–(12)** blinks 3 times.
- 04) Press and hold down the **RECORD button (21)** for 3 seconds to exit the mode. The LED on the button turns off.

6.5.3. Record a Chase Step

To record a chase step:

- 01) Press and hold down the **RECORD button (21)** for 3 seconds to enter programming mode. The LED on the button starts blinking.
- 02) Press the **USER CHASES button (16)** to enter User Chase mode. The LED on the button lights up.
- 03) Press one of the **COLORS/CHASES buttons (1)–(12)** to which you want to assign the chase. The LED on the button lights up.

Note:

Press a **COLORS/CHASES button (1)–(12)** to make sure that the button is free. If the LED on the button lights up, the button is not free.

You can adjust the color in one of the 3 ways:

- Manual setup: See **6.3.1. Manual Mode** on page 19 to set up the color manually
 - Preset color: See **6.3.2.1. Preset Colors Mode** on page 19 to select one of the 12 preset colors
 - User color: See **6.3.2.2. User Colors Mode** on page 20 to select one of the user-recorded colors
- 01) Press the **RECORD button (21)** to save the setting. The LEDs on all buttons blink 3 times.
 - 02) Program all steps in a chase. One chase can have up to 99 steps.
 - 03) Press and hold down the **RECORD button (21)** for 3 seconds to exit programming mode. The LED on the button turns off.

Note:

It is not possible to record strobe, speed, fade or direction in a chase. Adjust these functions during the playback of a chase.

6.5.4. Add a Chase Step to an Existing Chase

To add a chase step to a chase:

- 01) Press and hold down the **RECORD button (21)** for 3 seconds to enter programming mode. The LED on the button starts blinking.
- 02) Press the **USER CHASES button (16)** to enter User Chase mode. The LED on the button lights up.
- 03) Press the **COLORS/CHASES button (1)–(12)** for which you want to edit the chase. The LED on the button lights up.
- 04) Press the **STEP+ (19)** or the **STEP- (20)** button to select the step after which you want to add another step.
- 05) Set the color in one of the following 3 ways:
 - Manual setup: See **6.3.1. Manual Mode** on page 19 to set the color manually.
 - Preset color: See **6.3.2.1. Preset Colors Mode** on page 19 to select one of the 12 preset colors.
 - User color: See **6.3.2.2. User Colors Mode** on page 20 to select one of the user-recorded colors.
- 06) Press the **RECORD button (21)** to save the setting. The LEDs on all buttons blink 3 times.
- 07) Press and hold down the **RECORD button (21)** for 3 seconds to exit programming mode. The LED on the button turns off.

6.5.5. Delete a Chase Step

To delete a chase step:

- 01) Press and hold down the **RECORD button (21)** for 3 seconds to enter programming mode. The LED on the button starts blinking.
- 02) Press the **USER CHASES button (16)** to enter User Chase mode. The LED on the button lights up.
- 03) Press the **COLORS/CHASES button (1)–(12)** which you want to edit. The LED on the button lights up.
- 04) Press the **STEP+ (19)** or the **STEP- (20)** button to select the step which you want to delete.
- 05) Press the **DELETE button (22)** to delete the step.
- 06) Press and hold down the **RECORD button (21)** for 3 seconds to exit programming mode. The LED on the button turns off.

6.5.6. Delete a Chase

To delete a chase:

- 01) Press and hold down the **RECORD button (21)** for 3 seconds to enter programming mode. The LED on the button starts blinking.
- 02) Press the **USER CHASES button (16)** to enter User Chase mode. The LED on the button lights up.
- 03) Press the **COLORS/CHASES button (1)–(12)** which you want to edit. The LED on the button lights up.
- 04) Press the **DELETE button (22)** and the **COLORS/CHASES buttons (1)–(12)** at the same time, to delete the chase. The LEDs on all buttons blink 3 times.
- 05) Press and hold down the **RECORD button (21)** for 3 seconds to exit programming mode. The LED on the button turns off.

6.6. Factory Reset

You can delete all user-programmed colors and chases and set the fixture type to its default setting: RGBWA-UV.

Press and hold down the **RECORD button (21)**, the **DELETE button (22)** and the **CLEAR button (23)** at the same time for 5 seconds to restore the default factory settings. The LEDs on all buttons blink 3 times.

7. Troubleshooting

This troubleshooting guide contains solutions to problems which can be carried out by an ordinary person. The device does not contain user-serviceable parts.

Unauthorized modifications to the device will render the warranty void. Such modifications may result in injuries and material damage.

Refer servicing to instructed or skilled persons. Contact your Highlite International dealer in case the solution is not described in the table.

Problem	Probable cause(s)	Solution
The device does not turn on	The battery is depleted	<ul style="list-style-type: none"> Recharge the battery. See 4.3. Charging the Battery on page 12
The device responds erratically	The settings are incorrect	<ul style="list-style-type: none"> Reset the device to the factory settings. See 6.6. Factory Reset on page 24
The device does not function at all	No power to the device	<ul style="list-style-type: none"> Check if power is switched on and cables are plugged in
No light	Devices are not linked (wireless DMX)	<ul style="list-style-type: none"> Check if the device and the lighting fixtures are linked
	Bad connections	<ul style="list-style-type: none"> Check if the connections between the device and the lighting fixtures are correct
No DMX data transfer	Bad data link connection	<ul style="list-style-type: none"> Examine connections and cables. Correct poor connections. Repair or replace damaged cables
	The signal is reversed. The 3-pin DMX OUT of the device does not match the DMX IN of the lighting fixture	<ul style="list-style-type: none"> Install a phase-reversing cable between the device and the lighting fixture

8. Maintenance

8.1. Preventive Maintenance



Attention

Before use, examine the device visually for any defects.

Make sure that:

- All screws used for installing the device or parts of the device are tightly fastened and are not corroded.
- There are no deformations on housings, fixations and installation points.
- The power cables are not damaged and do not show any material fatigue.

8.1.1. Basic Cleaning Instructions

To clean the device, follow the steps below:

- 01) Disconnect the device from the electrical power supply.
- 02) Allow the device to cool down for 5 minutes.
- 03) Clean the device with a soft, lint-free cloth.



Attention

- Do not immerse the device in liquid.
- Do not use alcohol or solvents.

8.2. Corrective Maintenance

The device does not contain user-serviceable parts. Do not open the device and do not modify the device.

Refer repairs and servicing to instructed or skilled persons. Contact your Highlite International dealer for more information.

9. Deinstallation, Transportation and Storage

9.1. Instructions for Transportation

This device contains a rechargeable (secondary) lithium-ion battery. Lithium-ion batteries contained in equipment fall under the category of dangerous goods for transportation.

Make sure that you are in compliance with all applicable transportation regulations when you transport this device. See **3.3. Product Specifications** on page 10 for the specifications of the battery.

Use the original packaging to transport the device or other suitable packaging that complies with the regulations for transportation of secondary lithium-ion batteries.

9.2. Storage

This device contains a rechargeable (secondary) lithium-ion battery. The battery is not replaceable. The battery may explode or cause burns if it is crushed, disassembled or exposed to fire or high temperatures.

- Store the device in a dry place, at temperatures between 5 °C and 20 °C. Lithium-ion batteries self-discharge during storage. Temperatures above 20 °C speed up the self-discharging process.
- Do not store the device with depleted battery. Make sure that the battery is charged to at least 50 % before storing the device. See **4.3. Charging the Battery** on page 12.
- If the device is stored for an extended period, check the battery's charge status regularly. See **4.3.1. Battery Statuses** on page 13.
- Clean the device before storing. Follow the cleaning instructions in chapter **8.1.1. Basic Cleaning Instructions** on page 26.
- Store the device in the original packaging, if possible.

10. Disposal

This device contains a lithium-ion battery. Do not dispose of with the household waste.

Correct disposal of this product



Waste Electrical and Electronic Equipment

This symbol on the product, its packaging or documents indicates that the product shall not be treated as household waste. Dispose of this product by handing it to the respective collection point for recycling of electrical and electronic equipment. This is to avoid environmental damage or personal injury due to uncontrolled waste disposal. For more detailed information about recycling of this product contact the local authorities or the authorized dealer.

11. Approval



Hereby, Highlite International declares that the device ColorCue 1 AIR, product code 50707, is in compliance with Directive 2014/53/EU (RED – Radio Equipment Directive).

The full text of the EU declaration of conformity is available at the respective product page on the website of Highlite International (www.highlite.com).



©2023 Showtec